

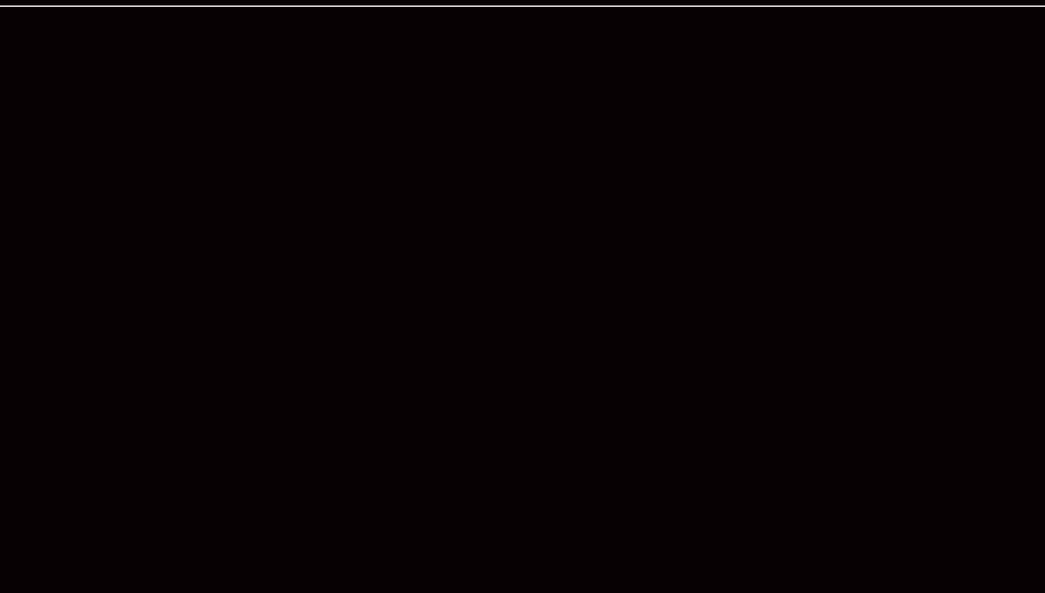

⚠ DANGER



T&P and ASME Safety Relief Valves



watts.com

WATTS®

Table of Contents

Temperature & Pressure Relief Valves

General Information

The Role of Temperature and Pressure Relief Valves in Water Heater Safety	.4
How T&P Valves Work	.4
Selecting T&P Valves	.4
ASME Pressure Steam Rating	.5
CSA Temperature Steam Rating	.4
Temperature Water Rating	.5
Pressure Relief Settings	.5
Installation	.5
Drain Lines	.6
Boiling Points of Water	.6
Thermal Expansion	.6
T&P Relief Valve Reinspection	.7

Commercial T&P Relief Valves

Series 40, 140, 240 and 340 Automatic Re-seating T&P Relief Valves	.8
Series LL40XL and LLL40XL Extended Shank Automatic Re-seating T&P Relief Valves	.9

Residential T&P Relief Valves

Series 1L, 1XL, 10L and 100XL ASME Rated Self-Closing T&P Relief Valves for Water Heaters	.10
Series SL100XL, L100XL, LL100XL and LLL100XL Extended Shank T&P Relief Valves	.11

Relief/Shutoff Valves

Series 210-5 Gas Shutoff Valves	.12
Model 3L Pressure Relief Valve	.13
Model 53L Pressure Relief Valve	.13

Accessories

Series 100DT T&P Relief Valve Drain Tubes	.14
---	-----

ASME Rated Pressure Relief Valves

General Information

The Role of ASME Rated Pressure Relief Valves in Water Heating Systems	.15
How ASME Rated Valves Work	.15
ASME Boiler and Pressure Vessel Code	.15
Installation	.15

ASME Water Pressure Relief Valves

Series 174A, 374A, 740	.16
------------------------	-----

General Information

The Role of Temperature and Pressure Relief Valves in Water Heater Safety

An exploding 30-gallon water heater has the force of about one pound of dynamite and has the power to destroy a house and injure or kill those inside. Thankfully, explosions have been significantly reduced because temperature and pressure (T&P) relief valves are now being used nationally to protect water heaters from explosion. T&P relief valves, when installed properly, prevent high water temperatures, which can cause flashing of hot steam at faucets or any water outlets in the system, or cause an explosion. And, they prevent high pressures, which can damage the water heater system piping or components.



How T&P Valves Work

T&P relief valves are two in one devices, responding to both excessive pressures and to excessive temperatures in a water heater. These are abnormal and potentially dangerous conditions.

First, they respond to excessive pressure by opening at the pressure set point of the valve, typically 150psi, to prevent further pressure increase. When a relief valve is dripping, it is typically due to thermal expansion. When water is heated, it expands. This causes excess pressure in the system. When the T&P relief valve senses this excess pressure, it opens relieving the thermal expansion* and returning the pressure back to normal conditions.

Second, they respond to excessive temperature. When the temperature of the water in the water heater reaches 210°F, the T&P relief valve's internal thermostatic element expands, lifting the valve's disc off its seat to discharge the overheated water. This allows cooler water to enter the tank and moderate temperatures. When the temperature returns to a safe level (under 210°F), the thermostat contracts, allowing the loading spring to reseat the valve. At this point the automatic temperature relieving element is ready to protect the system again. If a T&P relief valve is relieving a high volume of water, it is due to excessive water temperature*, an unsafe water heater condition*.

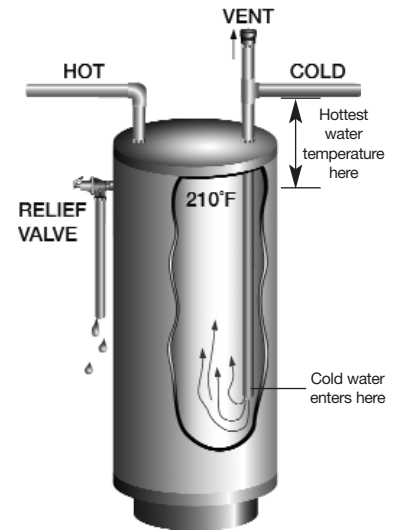

* Refer to page 6 for important safety information.

Selecting T&P Valves

To select a T&P valve some basic application factors must be considered: sizing, location in the water heater and draining. Sizing the valve is based on ensuring that the valve discharge rating is in excess of the BTU input as indicated on the manufacturer's label on the heater. The valve must be capable of discharging more BTU's than the heater is capable of putting into the water.

CSA Temperature Steam Rating

The CSA temperature steam rating, the method used under ANSI standard Z21.22, used nationally for sizing relief valves. The rating is obtained initially on a test tank where 15psi of steam pressure is accumulated. Under these conditions, the thermostat has opened the valve, and the steam flows through the orifice into an accumulating tank where it is measured and translated into a valve rating. This is the safest form of rating relief valves because it takes into consideration the fact that no water pressure is available to the heater. Therefore, it covers all potential elements that could affect the relieving capacity.

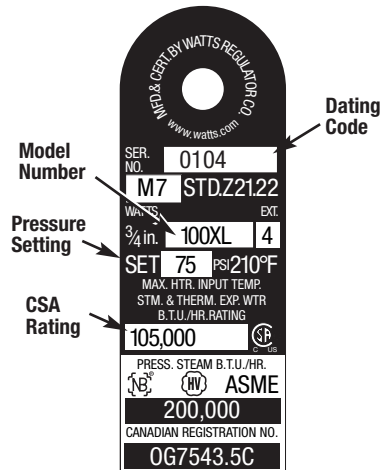

Sample T&P Valve Tags

* The Date code may be located on the underside of the test lever.

ASME Pressure Steam Rating

The ASME pressure steam rating should be considered with caution, because it represents the ability of the device to discharge steam pressure at the set pressure of the valve. For example, let's consider a 150psi set relief valve with an ASME pressure steam rating of 1,437,600 BTU per hour. Before this valve can deliver that rating, there must be generated within the tank over 150psi of steam pressure in order to actuate the valve. This is certainly an unsafe condition for a non-ASME-rated water heater tank. The tank could rupture and explode prior to reaching this ASME pressure rating. An ASME-rated tank is constructed to higher standards than a non-rated tank. It is important to understand which type of tank will be used in an application. For all non-ASME-rated tanks, the CSA temperature steam rating should always be used.

Pressure Relief Settings

Questions regarding relief valve settings frequently come up. For some years, 125psi was the standard setting. Today 150psi is considered the standard. The history of the 125psi setting stems from a water heater standard which formerly stated that the working pressure of the water heater tank would be designated at 42% of the test pressure. As most heaters were tested at 300psi, the working pressure figured out to 127psi. Thus, the 125psi valve became the standard setting. However, the water heater standard was changed to allow the working pressure to be 50% of the test pressure, resulting in the change to a pressure relief setting of 150psi. Under no circumstances should the relief valve setting of the valve exceed the working pressure of the tank, as this would violate all heater warranties and codes.

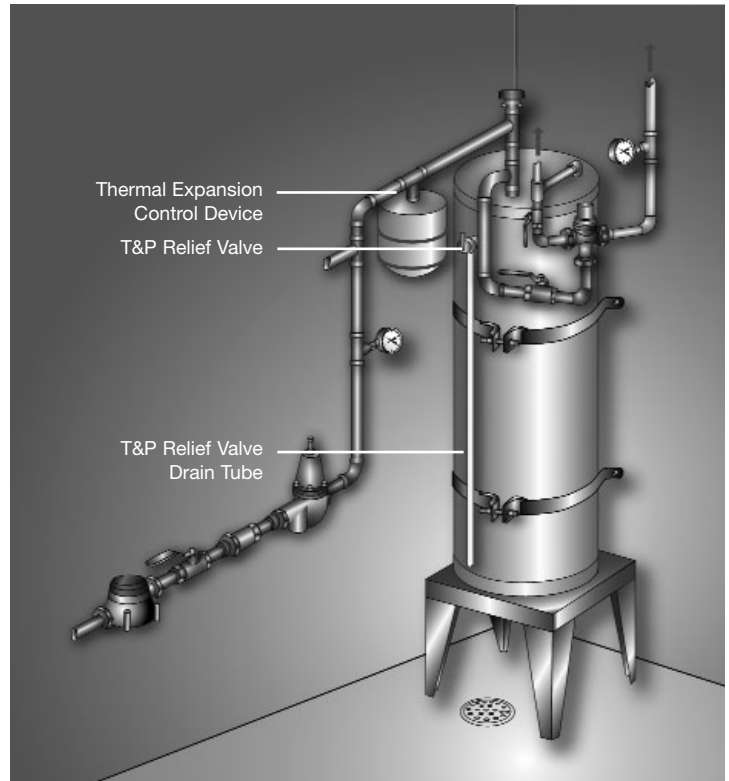

Typical Heater Installation

Location in Water Heater

Installation

The installation of temperature and pressure relief valves is critical. They must be installed so that the temperature sensing element is immersed in the hottest water in the tank. The hottest water is located in the top six inches of the tank. Most water heaters are equipped with a special tapping for the T&P valve at the proper location in the tank. If, however, the valve were to be installed a distance away from the tank, a thermal lag condition would be created, which simply means that the valve thermostat cannot respond to the hottest water in the top of the heater. For example, a 3/4" valve which is installed four inches from the tank would actually be sensing cooler water, and by the time the temperature of the water at the point of the valve reached 210°F, the temperature at the top of the tank would be 244°F. Another example: If the valve was installed ten inches away, when it finally sensed 210°F water, the temperature at the top of the tank would be 272°F. So the basic rule is to install the valve so that the temperature sensing element is immersed in the water in the top six inches of the tank. This may require the installation of an extended temperature sensing element.

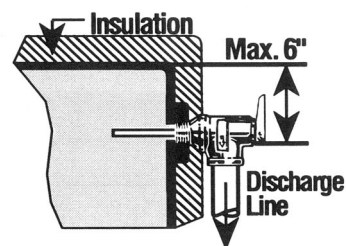

For Heaters with Direct Top Tapping

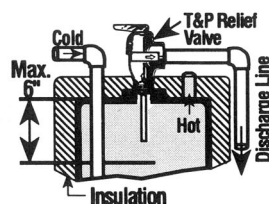

"Alternate" Only when the tappings are not provided

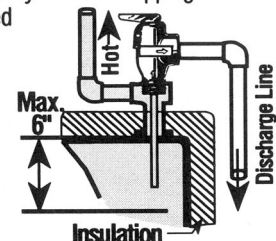

Use Standard or extra length extensions thermostat

Typical T&P Valve Installations

Drain Lines

A drain line must be connected to the discharge outlet of a T&P relief valve to avoid water damage and scalding injury. A drain line, the same size as the relief valve outlet, must be used in order to channel the discharge of hot water to a safe place of disposal. The drain line must pitch downward to allow for the complete drainage of both the valve and the line. The drain

line must never be trapped. Also, the drain line should not contain any shut-off valves, reducing couplings or restrictions. One must never plug or crimp or reduce the size of a drain line. **The T&P valve rating can only be achieved with a full sized discharge line.** The drain line should terminate above a floor drain or where any discharge will be clearly visible.

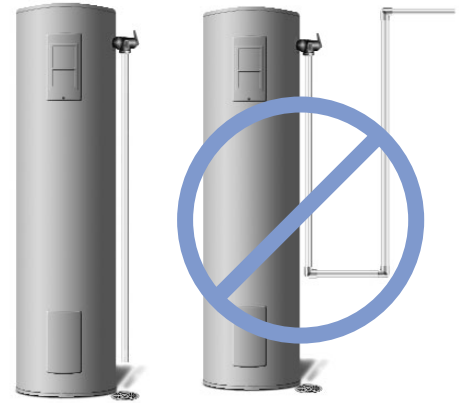

Watts Model 100DT drain lines are available for both T&P mount and side mount T&P valves.

Boiling Points of Water

Water is practically an incompressible solid, and unless it is superheated, it has no latent heat energy within itself to expand when released. However, water above 212°F is considered superheated water and does possess latent heat energy which, when exposed to atmospheric pressure, flashes into steam and creates

the energy which is the power behind an explosion. In an open vessel at atmospheric pressure, water will boil at 212°F. No matter how much heat is applied, there is no latent heat energy stored by the water. However, water in a closed system and under pressure has a much higher boiling point, which increases with pressure.

For example, where water supply pressure to the water heater is 90psi, the boiling point is not reached until 331.2°F. At only 50psi, water flashes into steam and boils at 297°F. This energy, if released by a water heater rupture, equals more than one pound of dynamite. Thus, it is essential to keep water temperature below 212°F.

Thermal Expansion

One of the more common question regarding T&P relief valves is why they drip. In most cases, dripping is caused by thermal expansion. When water is heated in a closed plumbing system, it expands, causing an increase in pressure. This increase in system pressure over that regulated by the pressure reducing valve is called thermal expansion pressure. **The T&P valve is a safety device and is not intended for continuous operation to relieve thermal expansion.**

Continuous dripping can cause the build up of mineral deposits on the valve and may render it useless.

A simple way to detect whether or not thermal expansion is the cause of a dripping relief valve is to open a fixture during the expansion period. Opening a fixture opens the system, and immediately the pressure will drop back to normal. A second method that is used to determine the maximum pressure of the system is to install a pressure test gauge with a telltale on a hose bibb connection. As the pressure increases, the gauge moves the telltale. By leaving the gauge on the system for 24 hours, the telltale will remain at the highest pressure registered on the system.

Watts model 276H300 or IWTG water pressure test gauges can do just that. They connect to any standard hose bibb for easy thermal expansion detection.



276H300

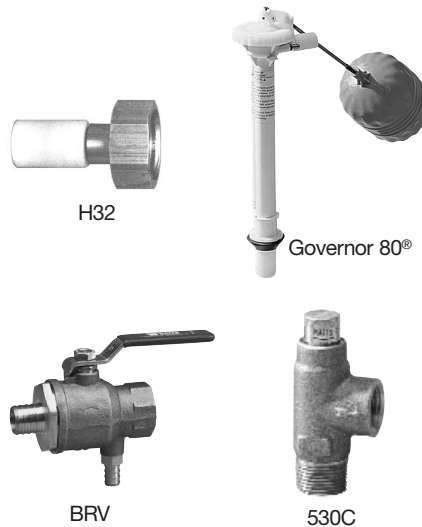

Thermal expansion problems can be solved by using a thermal expansion relief device on the system. Devices include auxiliary type relief valves which can be placed anywhere on the system and set approximately to 10psi below the water heater relief valve setting. They allow the auxiliary relief valve to take the brunt of thermal expansion relieving, and prevent unnecessary relieving cycles by the T&P relief valve.

Watts offers the model 530C, H32 and BRV. Watts also offers the Governor 80® combination toilet ballcock and thermal expansion relief valve. The Governor 80® discharges thermally expanded water into the toilet tank.

Another solution is to use an expansion tank. With this method, the expanded volume of water remains contained within the system, which is important where water conservation is a concern. Expansion tanks consist of an air chamber separated by a flexible diaphragm. When thermal expansion occurs, the excess water created is absorbed by the tank. When the tap is opened, the water is then forced by the tank back into the system. Watts offers several potable water expansion tanks including the models DET, PLT and DETA.



DET



PLT



DETA

T&P Relief Valve Reinspection

Temperature and pressure relief valves should be reinspected at least once every three years by a licensed plumbing contractor or authorized inspection agency to ensure that the product has not been affected by corrosive water condition and to ensure that the valve and discharge line have not been altered or tampered with illegally. Certain naturally occurring conditions may corrode the valve or its components over time, rendering the

valve inoperative. Such conditions are not detectable unless the valve and its components are physically removed and inspected. An unauthorized person must not attempt to conduct this inspection.



Mineral build-up can render T&P Valve inoperative.



Contact a plumbing contractor for a reinspection to assure continuing safety. Failure to reinspect as directed could result in unsafe temperature or pressure build-up that can result in serious injury or death and/or severe property damage.

Watts recommends using the following checklist when reinspecting T&P relief valves:

ITEM TO INSPECT	WHAT TO DO	PURPOSE
1. Test Lever	Manually lift lever	Following installation, the valve lever MUST be operated AT LEAST ONCE A YEAR to ensure that waterways are clear. Certain naturally occurring mineral deposits may adhere to the valve, blocking waterways, rendering it inoperative. When the lever is operated, hot water will discharge if the waterways are clear. PRECAUTIONS MUST BE TAKEN TO AVOID PERSONAL INJURY FROM CONTACT WITH HOT WATER AND TO AVOID PROPERTY DAMAGE.
2. Valve Location	Observe how valve is installed	Valve thermostat must be immersed in tank water and located in top 6" of tank to accurately sense temperature.
3. Discharge Line	Observe size and direction	Discharge line must always be installed to avoid water damage and scalding injury, when valve operates. Discharge line must be same size as valve outlet, be pitched down for free draining, and have no shut-off valve or obstructions throughout its entire length. Discharge line termination point should be visible to observe any discharge.
4. Nameplate	A. Observe Pressure Setting B. Observe CSA rating C. Observe Type number D. Observe Dating Code*	Pressure Relief Setting cannot exceed working pressure of tank. CSA Rating must be in excess of BTU input of heater. To ensure that valve is temperature and pressure type rather than plain pressure relief. To determine age of valve, all devices have a 4 digit serial number dating code. The first two digits are the year and the last two digits are the week of the year the valve was manufactured (i.e. 0520 is 20th week of 2005.)
5. Complete Valve	Remove valve from tank	TEMPERATURE AND PRESSURE RELIEF VALVES should be inspected AT LEAST ONCE EVERY THREE YEARS , and replaced, if necessary, by a licensed plumbing contractor or qualified service technician, to ensure that the product has not been affected by corrosive water conditions and to ensure that the valve and discharge line have not been altered or tampered with illegally. Certain naturally occurring conditions may corrode the valve or its components over time, rendering the valve inoperative. Such conditions can only be detected if the valve and its components are physically removed and inspected. Do not attempt to conduct an inspection on your own. Contact your local licensed plumbing contractor for a reinspection to assure continuing safety.
6. Inspection Log	Log inspection data	To provide record of inspection date and results of inspection.

*The date code may be located on the underside of the test lever or on the metal nametag.

Commercial T&P Relief Valves

Series 40, 140, 240 and 340

Automatic Re-seating T&P Relief Valves

Series 40, 140, 240 and 340 automatic re-seating T&P relief valves provide the least expensive and proven means for protection against both excessive temperature and pressure emergency conditions.

This series features fully automatic temperature and pressure relief protection for commercial hot water supply tanks and heaters based on the latest ANSI Z21.22 listing requirements for temperature discharge capacity.

Series 40XL comes with test lever and extension thermostat for installation in hot water outlet within the allowable distance from the top of the tank based on latest ANSI Z21.22. Available in sizes 3/4" and 1" (20-25mm).

Series 40L with test lever and short thermostat for installation directly in available tank tapings. Available in sizes 3/4" and 1" (20-25mm).

Series 140, N240 and 340 have the same basic body construction and advanced design features as the 40 series except for their discharge capacity and size of inlet and outlet connections. Available in sizes: 1", 1 1/4", 1 1/2" and 2" (25, 32, 40 and 50mm).

Features

- Bronze body construction
- Non-mechanical seat-to-disc alignment
- Thermostat is accurate and proven. Exclusively designed and manufactured by Watts
- Tamper-resistant bonnet screws
- Series 40 and 140 feature a unique thermostat with a special thermo-bonded coating
- 1" (25mm) and above sizes models M15, M2 and M4 come standard with stainless steel thermostat tube

Standards



ASME Rated, ANSI Z21.22, Design certified and listed by CSA, National Board of B&PVI to Section IV of the ASME B&PV code and meet current FHA requirements and ANSI Z21.22 in addition to Military Spec. MIL-V-136-12D, Type I.

Note: Model 340X-8 1 1/2" size only. Pressure setting 175psi (12.1 bar), temperature 210°F (99°C), certified by CSA only.



40L, 40XL

140X

N240X

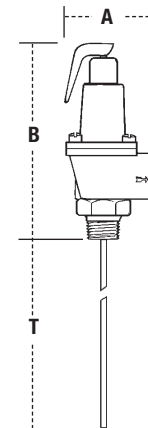

340

MODEL	SIZE (DN)		THERMOSTAT LENGTH		DIMENSIONS				CSA TEMP. STEAM RATING	ASME PRESSURE STEAM RATING	ASME PRESSURE STEAM RATING	WEIGHT	
	M = Male F = Female Inlet x Outlet		T		A		B Less Thermostat					BTU/hr.	BTU/hr.** @75psi set pressure
	in.	mm	in.	mm	in.	mm	in.	mm					
40L-3	3/4M x 3/4F	20 x 20	3	76	2 5/8	67	5 5/8	143	180,000	777,600	1,437,600	1.75	0.79
40XL-5	3/4M x 3/4F	20 x 20	5	127	2 5/8	67	5 5/8	143	205,000	777,600	1,437,600	1.75	0.79
40XL-8	3/4M x 3/4F	20 x 20	8	200	2 5/8	67	5 5/8	143	205,000	777,600	1,437,600	1.75	0.79
140S-3	3/4F x 3/4F	20 x 20	3	76	2 5/8	67	5 5/8	143	180,000	777,600	1,437,600	1.75	0.79
140X-5	3/4F x 3/4F	20 x 20	5	127	2 5/8	67	5 5/8	143	205,000	777,600	1,437,600	1.75	0.79
140X-8	3/4F x 3/4F	20 x 20	8	200	2 5/8	67	5 5/8	143	205,000	777,600	1,437,600	1.75	0.79
40L-2	1M x 1F	25 x 25	2	50	2 3/4	70	6 1/4	158	450,000	1,155,000	2,134,000	2.25	1.0
40XL-4	1M x 1F	25 x 25	4	100	2 3/4	70	6 1/4	158	500,000	1,555,000	2,134,000	2.25	1.0
40XL-7	1M x 1F	25 x 25	7	178	2 3/4	70	6 1/4	158	500,000	1,555,000	2,134,000	2.25	1.0
140S-3	1F x 1F	25 x 25	3	76	3	76	5 1/2	140	570,000	1,670,000	3,085,000	2.25	1.0
140X-6	1F x 1F	25 x 25	6	150	3	76	5 1/2	140	670,000	1,670,000	3,085,000	2.25	1.0
140 X-9	1F x 1F	25 x 25	9	229	3	76	5 1/2	140	670,000	1,670,000	3,085,000	2.25	1.0
N240X-6	1F x 1F	25 x 25	6	150	3 3/8	86	6 5/8	168	730,000	2,195,000	4,059,000	2.75	1.2
N240X-9	1F x 1F	25 x 25	9	229	3 3/8	86	6 5/8	168	730,000	2,195,000	4,059,000	2.75	1.2
N241X-5	1 1/4M x 1F	32 x 25	5	127	3 3/8	86	6 5/8	168	730,000	2,195,000	4,059,000	2.75	1.2
N241X-8	1 1/4M x 1F	32 x 25	8	200	3 3/8	86	6 5/8	168	730,000	2,195,000	4,059,000	2.75	1.2
340-3	1 1/2F x 1 1/2F	40 x 40	3	76	4 1/2	114	9 3/4	248	1,150,000	3,450,000	6,379,000	7	3.0
340X-8	1 1/2F x 1 1/2F	40 x 40	8	200	4 1/2	114	9 3/4	248	1,150,000	3,450,000	6,379,000	8	3.6
342-3	2M x 1 1/2F	50 x 40	3	76	4 1/2	114	9 3/4	248	1,150,000	3,450,000	6,379,000	7	3.0
342X-8	2M x 1 1/2F	50 x 40	8	200	4 1/2	114	9 3/4	248	1,150,000	3,450,000	6,379,000	8	3.6

**ASME capacities are steam pressure ratings and do not reflect the CSA temperature relieving capacity of the valves for selection purposes.

Series LL40XL and LLL40XL

Extended Shank Automatic Re-seating T&P Relief Valves

Series LL40XL and LLL40XL extended shank automatic re-seating T&P Valves are combined 2-in-1 temperature and pressure relief valves that provide the least expense and proven means for protection against both excessive temperature and pressure emergency conditions. These valves feature full automatic temperature and pressure relief protection for commercial hot water supply tanks and heaters based on the latest ANSI Z21.22 listing requirements for temperature discharge capacity.

The LL40-XL and LLL40-XL feature test lever and extended inlet shank for use with the new generation of water heaters with extra thick insulation. These valves eliminate the use of an extension nipple that is required with standard shank length models.

Features

- Bronze body construction
- Non-mechanical seat-to-disc alignment
- Thermostat is accurate and proven; exclusively designed and manufactured by Watts Regulator Company tamper-resistant bonnet screws
- Unique thermostat with special thermo-bonded coating

Standards



ASME Rated, ANSI Z21.22, Design certified and listed by CSA, National Board of B&PVI to Section IV of the ASME B&PV code and meet current FHA requirements and ANSI Z21.22 in addition to Military Spec. MIL-V-136-12D, Type I.

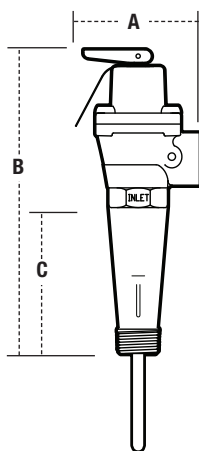
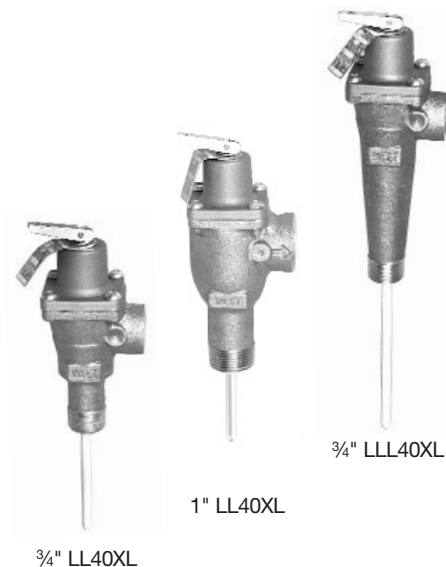

MODEL	SIZE (DN)		THERMOSTAT LENGTH		DIMENSIONS						CSA TEMP. STEAM RATING	ASME PRESSURE STEAM RATING	ASME PRESSURE STEAM RATING	WEIGHT	
	M = Male F = Female Inlet x Outlet		(below inlet)		A		B Less Thermostat		C					BTU/hr.	BTU/hr.** @75psi set pressure
	in. x in.	mm x mm	in.	mm	in.	mm	in.	mm	in.	mm					
LL40XL	3/4M x 3/4F	20 x 20	3 1/2	89	2 5/8	67	5 5/8	143	1 21/32	42	205,000	777,600	1,437,600	1.5	0.68
LLL40XL	3/4M x 3/4F	20 x 20	5	127	2 5/8	67	7 7/8	194	3 21/32	93	205,000	777,600	1,437,600	2	0.90
LL40XL	1M x 1F	25 x 25	3	76	2 3/4	70	6 1/2	165	1 25/32	45	500,000	1,155,000	2,134,000	2	0.90

**ASME capacities are steam pressure ratings and do not reflect the CSA temperature relieving capacity of the valves for selection purposes.

Residential T&P Relief Valves

Series 1L, 1XL, 10L and 100XL

ASME rated self-closing T&P Relief Valves for Water Heaters

Series 1L, 1XL, 10L and 100XL ASME rated self-closing T&P relief valves are ideal for water heaters up to 105,000 BTU/Hr. These combined 2 in 1 T&P relief valves provide the least expensive and proven means for protection against both excessive temperature and pressure emergency conditions.

Series 1L, 1XL and 10L are furnished with test lever and short thermostat for installation directly in tank tapping.

Series 100XL furnished with test lever and extension thermostat for installation in the hot water outlet line or directly in the tank tapping.

Temperature sensing element must be immersed in the water within the top 6" (152mm) of the tank. Male inlet and female outlet. Temperature relief 210°F (99°C). Standard settings 75, 100, 125, 150psi (5.2, 6.9, 8.6, 10.3 bar).

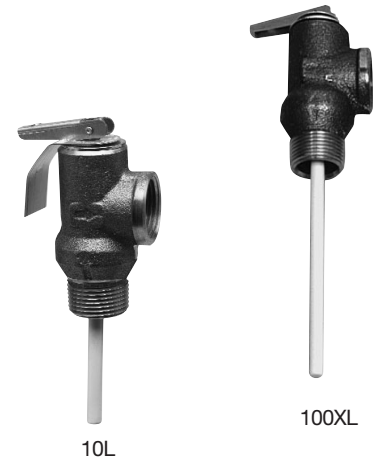

Features

- Series 1L, 1XL, 10L and 100XL - Size 3/4" (20mm) (A.S.M.E. Rated*, CSA Listed) Feature a unique thermostat with special thermo-bonded coating.
- All bronze body.
- Stainless steel spring.
- Thermostat is accurate and proven. Exclusively designed and manufactured by Watts.

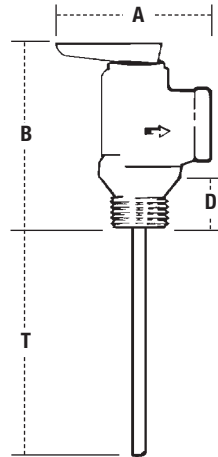

MODEL	SIZE (DN)		DIMENSIONS (APPROX.)								CSA		WEIGHT	
	in.	mm	A		B		D		T		Temp. Steam Rating Rating BTU/hr.	lbs.	kgs.	
1L2	1/2	15	1 3/4	43	3 1/2	89	7/8	22	2	50		15,000	0.6	0.2
1XL	1/2	15	1 3/4	43	3 1/2	89	7/8	22	3	76	15,000	0.7	0.3	
1XL-8	1/2	15	1 3/4	43	3 1/2	89	7/8	22	8	203	15,000	1	0.4	
10L-2	3/4	20	1 3/4	43	3 1/2	89	1 1/8	29	2	50	80,000	0.6	0.2	
100XL	3/4	20	1 3/4	43	3 1/2	89	1 1/8	29	3	76	105,000	0.7	0.3	
100XL-8	3/4	20	1 3/4	43	3 1/2	89	1 1/8	29	8	203	105,000	0.8	0.4	

*Series 1L and 1XL Valves are not ASME Listed or Rated.

Series SL100XL, L100XL, LL100XL and LLL100XL

ASME Rated Extended Shank T&P Relief Valves

Series SL100XL, L100XL, LL100XL and LLL100XL ASME rated extended shank T&P relief valves are ideal for hot water storage tanks up to 105,000 BTU/Hr. These combined 2-in-1 Temperature & Pressure relief valves provide the least expensive and proven means for protection against both excessive temperature and pressure emergency conditions. Series SL100XL, LL100XL and LLL100XL are design certified and listed by CSA and ASME. These valves eliminate the use of an extension nipple required with standard shank length models. The temperature sensing element must be immersed in the water within the top 6" (152mm) of the tank. Male inlet and female outlet. Temperature relief 210°F (99°C). Standard setting 75, 100, 125, 150psi (5.2, 6.9, 8.6, 10.3 bar).

Series SL100XL, L100XL, LL100XL and LLL100XL have extended inlet shanks for use with the new generation of water heaters containing extra thick insulation.

Features

- Thermostats with special protective coating
- All bronze body
- Stainless steel spring
- Thermostat is accurate and proven; exclusively designed and manufactured by Watts.
- SL100XL Extended inlet model for installations with thick insulation; suitable for water heaters with up to 1¾" (44.5mm) of insulation. (105,000 BTU)
- L100XL Extended inlet model for installations with thick insulation; suitable for water heaters with up to 2" (50.8mm) of insulation. (105,000 BTU)
- LL100XL Extra extended inlet model; suitable for water heaters with up to 2½" (63.5mm) of insulation. (105,000 BTU)
- LLL100XL Extra extended inlet model. Suitable for water heaters with up to 3" (76mm) of insulation (105,000 BTU)

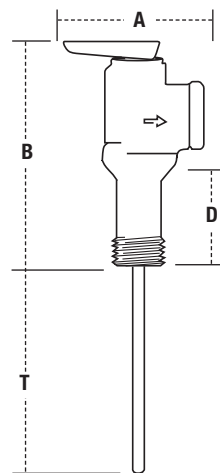
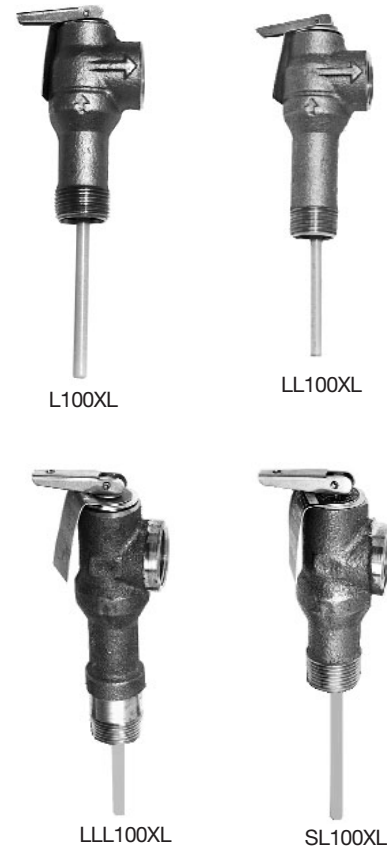

MODEL	SIZE (DN)		DIMENSIONS (APPROX.)								CSA Temp. Steam Rating BTU/hr.	WEIGHT	
	in.	mm	A		B		D		T			lbs.	kgs.
SL100XL	¾	20	1¾	43	4⅜	111	1¼	32	3½	89	105,000	0.7	0.3
L100XL	¾	20	1¾	43	4¼	108	1½	38	3	76	105,000	0.7	0.3
LL100XL	¾	20	1¾	43	4¾	121	2	50	2½	64	105,000	0.7	0.3
LLL100XL-Z5	¾	20	1¾	43	5¼	133	2½	64	2⅝	54	105,000	0.7	0.3

Relief/Shutoff Valves

Series 210-5

Gas Shut-off Valves

Series 210-5 automatic gas shutoff valves are positive-acting energy shutoff for the emergency temperature protection of gas water heaters. They are a self-contained devices independent of all other operating controls. The Series 210-5 provides protection against over-heating water in the domestic hot water supply heating system by automatically shutting off the gas supply to the heater in the event that the water temperature reaches 210°F (99°C). Series 210-5 must be manually reset in order to resume heater service. This feature serves as a warning of malfunctioning of the normal operating controls. Manual resetting is easily done and does not require dismantling or replacing of any part of the valve.

This gas shutoff differs from other contemporary designs in that Watts engineers have embodied the time tested Watts auto-thermatic thermal actuator principle along with a snap-acting trip latch which closes the valve at a definite controlled temperature.

Models L210-5 M2, LL210-5 M2 and LLL210-5 M2 feature extended shanks for use with the new generation of water heaters containing extra thick insulation

Used in conjunction with the Model 3L ASME rated Relief Valve to provide protection against excessive pressure.

Features

- **Seating** – Buna-N disc to metal seating assures positive seal for shutting off the gas to burner in the event of high water temperature conditions
- **Reset Button** – After operating from high temperature, the gas shutoff must be manually reset (opened). Pressing the reset button in as far as it will go and then releasing, opens the valve and allows gas to again flow to the burner

- **Trip Latch Assembly** – Snap acting latch releases the valve to closed at a definite controlled temperature. Stainless steel spring seats valve when trip latch releases valve to closed position
- **Thermostat** – Operates trip latch in response to water temperature. Thermobulb, temperature sensitive portion, is at end of extension tube for accurate response to tank temperature

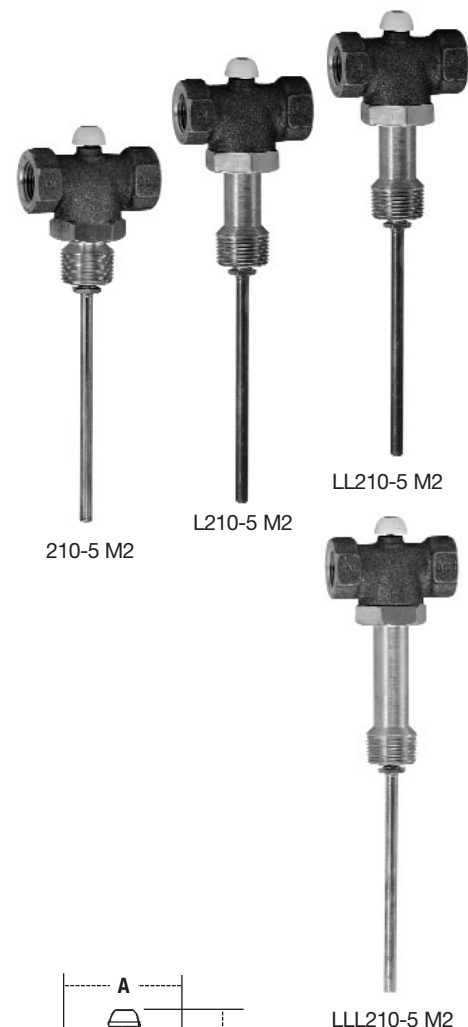

MODEL	DIMENSIONS								WEIGHT	
	A		B		C		D		lbs	kgs.
	in.	mm	in.	mm	in.	mm	in.	mm		
210-5 M2	2½	64	1⅛	29	8	203	7⅛	22	1.0	0.45
L210-5 M2	2½	64	1⅛	29	7 ¹³ / ₁₆	198	1⅞	48	1.0	0.45
LL210-5 M2	2½	64	1⅛	29	8 ⁵ / ₁₆	211	2¾	60	1.0	0.45
LLL210-5 M2	2½	64	1⅛	29	8 ¹³ / ₁₆	224	2⅞	73	1.0	0.45

MODELS	Connections		Natural Gas	L.P. Gas	BTU/HR RATINGS	
	Tank	Gas			M.F.G. and L.P. Gas Air Mixtures	Mixed Gases
210-5 M2, L210-5 M2, LL210-5 M2, LLL210-5 M2	¾" male	½" female	150,000	243,000	77,400	125,750

Model 3L

Pressure Relief Valve

Model 3L Pressure Relief Valve is ideal for protection against excessive pressure on domestic storage tanks or tankless water heaters. Similar in construction to Watts Model 10L, the Model 3L has no temperature relieving element. The Model 3L has a pressure range 75-150psi (5.2-10.3 bar) and standard settings of 75, 100, 125 and 150psi (5.2, 6.9, 8.6 and 10.3 bar). Size 3/4" x 3/4" (20mm x 20mm). The Model 3L provides overpressure protection when used in conjunction with the Series 210-5 gas shutoff valve on gas water heaters which is used to shut off the gas to the heater if water heater temperature exceeds 210°F. The Model 3L features ASME construction and is tested, listed and certified by the National Board of Boiler and Pressure Vessel Inspectors.



3L

Features

- Pressure range of 17-150psi (5.2-10.3 bar)
- Size 3/4" x 3/4" (20 x 20mm)
- ASME construction
- Tested, listed and certified by National Board of Boiler and Pressure Vessel Inspectors

MODEL	SIZE (DN)	
	<i>in.</i>	<i>mm</i>
3L	3/4	20

Model 53L

Pressure Relief Valve

Model 53L has the same basic design as Model 3L except it is furnished in 1/2" (15mm) size and does not comply with ASME requirements. The Model 53L features a bronze body and stainless steel internal spring.



53L

Features

- Size 1/2" (15mm)
- Bronze body and stainless steel spring

MODEL	SIZE (DN)	
	<i>in.</i>	<i>mm</i>
53L	1/2	15

Accessories

Series 100DT

Drain Tubes for use on Side or Top Mounted T&P Safety Relief Valves

Series 100DT Drain Tubes are used to easily provide a safe discharge line from residential water heater temperature and pressure relief valves. No special tools, fittings or sealants are required to install these drain tubes, they are simply hand-tightened to the T&P valve discharge.

Features

- Models available for both side mounted T&P relief valves (100DT, 100DT-T2) and for top mounted T&P relief valves (100DT-A60, 100DT-A60-12)
- No special tools required to install, simply hand-tighten
- Can be used on gas, electric or oil fired water heaters
- CSA and IAPMO listed

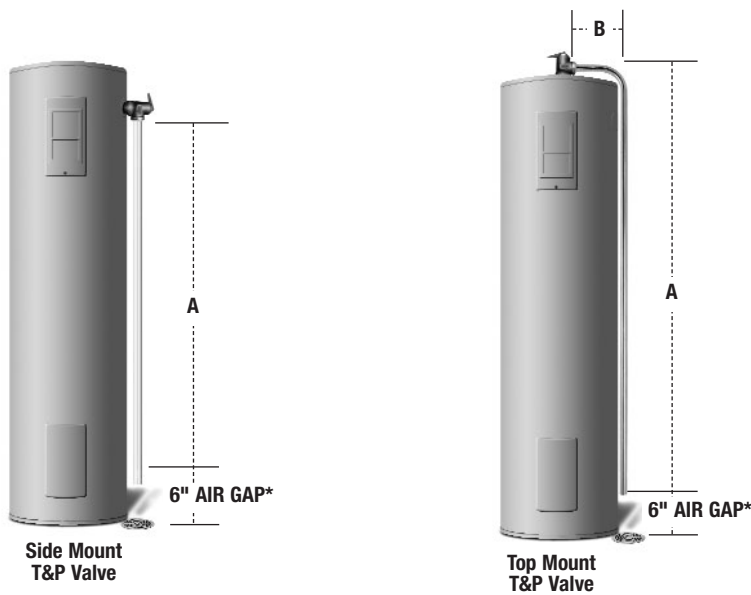

MODEL	CONNECTION SIZE (DN)		DIMENSIONS (APPROX.)			
	<i>in.</i>	<i>mm</i>	A Drop length		B Run	
	<i>in.</i>	<i>mm</i>	<i>in.</i>	<i>mm</i>	<i>in.</i>	<i>mm</i>
100DT	3/4	20	48	1219	—	—
100DT - 72	3/4	20	72	1829	—	—
100DT - A60	3/4	20	60	1524	8	203
100DT - A60 - 12	3/4	20	60	1524	12	305

General Information

The Role of ASME Rated Pressure Relief Valves in Water Heating Systems

Hot water boiler systems are designed to operate safely at temperatures higher than the atmospheric boiling temperature of water, but at relatively low pressures. Watts ASME rated pressure relief valves protect against excessive pressure conditions only.

Watts offers one of the most advanced designs of ASME rated water pressure relief protection for hot water boilers. Watts valves feature high accuracy and a tight seal by utilizing non-metallic disc-to-metal seating. Watts ASME rated pressure relief valves meet all performance requirements of the ASME Low Pressure Heating Boiler Code. Watts valves also feature the first ever nonmechanically guided stick-resistant design.

Hot water boilers normally operate full of water. If steam forms, this is a sign of a malfunction with the firing controls. When this occurs the energy stored in the boiler should be reduced, lowering the heat content of the boiler as rapidly as possible. This is the function the ASME rated pressure relief valves perform.

It is important that a relief valve work in both water and steam conditions. When steam forms in a hot water boiler it is a sign of an emergency temperature condition that must be relieved. Watts ASME rated pressure relief valves discharge excessive water pressure created by thermal expansion as well as steam conditions. These valves feature a built in steam rated pressure safety relief feature and exceptionally high BTU steam discharge capacity ratings.

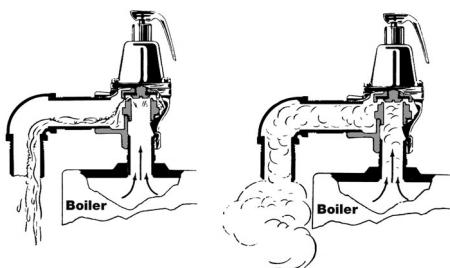
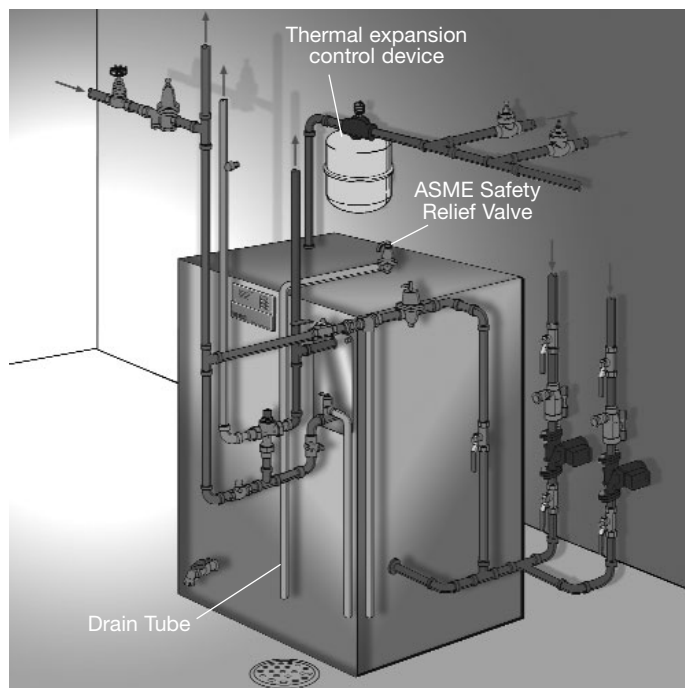

How ASME Rated Valves Work

Watts ASME rated pressure relief valves act as both a water pressure relief valve as well as a steam safety relief valve.

As thermal expansion (see thermal expansion section on page 6 of this guide) conditions develop, pressures may be built up to the setting of the relief valve. In this case the relief valve will then discharge this expanded water, just as a water pressure relief valve would do.

Should operating controls fail, permitting runaway firing, the boiler water may reach steam-forming temperatures, creating a steam pressure condition. In this case the relief valve will then discharge steam at the rate or faster than the boiler can generate it, thus restoring system pressure to a safer level, just as a steam safety relief valve would do.

ASME Boiler and Pressure Vessel Code

The following is from the ASME Boiler and Pressure Vessel Code Section IV – Low Pressure Heating Boilers

“Each hot water heating boiler shall have at least one officially rated pressure relief valve set to relieve at or below the maximum allowable working pressure of the boiler.”

Installation

The installation of a safety relief valve is essential. These devices are designed for emergency safety relief and shall not be used as an operating control. Valves should not be used on coal or wood boilers having an uncontrolled BTU heat input.

Safety relief valves shall be connected to the top of the boiler with the valve in the vertical position, either directly to a

topped or flanged opening in the boiler, to a fitting connected to the boiler by a close nipple, to a Y base, to a valveless header, connecting water outlets on the same boiler, or to a valveless water pipe between adjacent boilers. To avoid water damage or scalding due to valve operation, a discharge line must be connected to valve outlet and run to a safe place of disposal. Discharge lines must be as short as possible and be the same size as the valve discharge connection throughout its entire length. Discharge line must pitch downward from the valve and terminate at least 6" (152mm) above the floor drain where any discharge will be clearly visible. The discharge line shall terminate plain, not threaded, with a material serviceable for temperatures of 375°F (191°C) or greater. No shutoff valve shall be installed between the relief valve and boiler, or in the discharge line.

If discharge occurs, call a plumber immediately. A licensed plumbing contractor

must evaluate the system and determine the cause of discharge and correct the cause immediately. Discharge may indicate that unsafe pressure conditions exist which require immediate attention by a licensed plumbing contractor.

WARNING: Following installation, the valve lever must be operated at least once a year by the boiler owner to ensure that waterways are clear. Certain naturally occurring mineral deposits may adhere to the valve, rendering it inoperative. When manually operating the lever, water will discharge and precautions must be taken to avoid contact with hot water and to avoid water damage. Before operating lever, check to see that a discharge line is connected to this valve directing the flow of hot water from the valve to a proper place of disposal otherwise personal injury may result. If no water flows, valve is inoperative. Call a licensed plumber immediately

ASME Rated Pressure Relief Valves

Series 174A, 374A, 740

ASME Pressure Relief Valves

Series 174A bronze body ASME rated pressure relief valves are for pressure protection only of all types of **hot water heating boiler equipment and hot water space heating boilers**. This series has a pressure range of 30 to 150psi (2.1 - 10.3 bar) with corresponding high ratings from 650,000 to 14,370,000 BTU/hr. The Series 174A features female inlet and outlet connections and is available in sizes ¾" to 2" (20 to 50mm).

Series 374A iron body pressure relief valves with forged bronze inlet have a 550,000 BTU/hr pressure rating and are available in size ¾" (20mm) only.

Series 740 iron body pressure relief valves feature expanded outlets for hot water space heating boilers. The Series 740 has a pressure range of 30 to 75psi (2.1 to 5.2 bar) with corresponding high ratings from 925,000 to 10,700,000

BTU/hr.

Features

- Seat located above drain so water can not be trapped and sediment can not foul seat
- Non-mechanical seat-to-disc alignment will not stick or freeze

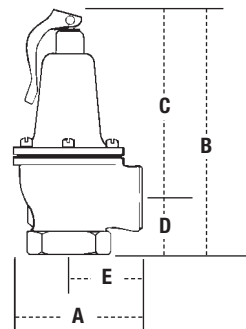

MODEL	SIZE (DN)		DIMENSIONS (APPROX.)										WEIGHT	
	in.	mm	A		B		C		D		E		lbs.	kg.
174A, 374A														
174A	¾	20	2½	64	4⅞	124	3¾	95	1⅞	29	1⅝	41	1.5	0.7
174A	1	25	3	76	5⅞	149	4⅜	111	1½	38	1⅞	48	3.1	1.4
174A	1¼	32	4¾	121	8½	216	6⅝	162	2⅞	54	2⅜	60	6.3	2.8
174A	1½	40	4⅞	124	9¼	235	6¾	171	2½	64	2⅝	67	7.3	3.3
174A	2	50	6½	165	10¼	260	7¼	184	3	76	3⅜	86	13.8	6.2
374A	¾	20	2½	64	3⅝	72	2⅜	60	1¼	32	1½	38	1.1	0.5

740	Inlet x Outlet													
740	¾ x 1	20-25	3	76	5⅞	149	4⅜	111	1½	38	1⅞	48	1.9	.9
740	1 x 1¼	25-32	3½	89	7¼	184	5⅜	137	1⅞	48	2⅞	54	3.1	1.4
740	1¼ x 1½	32-40	4⅝	117	8¾	222	6½	165	2¼	57	2⅝	67	6.1	2.8
740	1½ x 2	40-50	5¼	133	9¼	235	7	178	2¼	57	3	76	7.5	3.4
740	2 x 2½	50-65	6¾	171	11⅞	295	8¾	222	2⅞	73	3⅞	98	16.5	7.5

Capacity*

BTU/hr Steam Pressure Discharge Capacities

As tested and rated by the National Board of Boiler and Pressure Vessel Inspectors

		SERIES 174A				
Set Pressure <i>psi</i> <i>bar</i>	$\frac{3}{4}$ " x $\frac{3}{4}$ "	1" x 1"	1 $\frac{1}{4}$ " x 1 $\frac{1}{4}$ "	1 $\frac{1}{2}$ " x 1 $\frac{1}{2}$ "	2" x 2"	
	20 x 20mm <i>Model M3</i>	25 x 25mm <i>Model M1</i>	32 x 32mm <i>Model M1</i>	40 x 40mm <i>Model M</i>	50 x 50mm <i>Model M</i>	
30	2.07	650,000	1,005,000	1,682,000	2,020,000	3,815,000
33	2.27	695,000	1,075,000	1,788,000	2,150,000	4,080,000
35	2.41	725,000	1,125,000	1,877,000	2,250,000	4,250,000
36	2.48	740,000	1,145,000	1,916,000	2,310,000	4,344,000
40	2.76	800,000	1,240,000	2,071,000	2,490,000	4,690,000
45	3.10	875,000	1,355,000	2,265,000	2,720,000	5,130,000
50	3.45	950,000	1,470,000	2,459,000	2,950,000	5,575,000
55	3.79	1,025,000	1,590,000	2,653,000	3,190,000	6,010,000
60	4.13	1,100,000	1,702,000	2,847,000	3,425,000	6,450,000
65	4.58	1,170,000	1,820,000	3,041,000	3,660,000	6,890,000
70	4.82	1,245,000	1,935,000	3,325,000	3,890,000	7,330,000
75	5.17	1,320,000	2,055,000	3,429,000	4,125,000	7,770,000
80	5.51	1,400,000	2,166,000	3,605,000	4,360,000	8,215,000
85	5.86	1,470,000	2,285,000	3,817,000	4,590,000	8,650,000
90	6.60	1,545,000	2,400,000	4,011,000	4,825,000	9,090,000
95	6.55	1,620,000	2,520,000	4,205,000	5,060,000	9,530,000
100	6.89	1,695,000	2,635,000	4,399,000	5,290,000	9,970,000
105	7.23	1,770,000	2,750,000	4,593,000	5,525,000	10,410,000
110	7.58	1,845,000	2,865,000	4,787,000	5,760,000	10,850,000
115	7.92	1,920,000	2,980,000	4,981,000	5,990,000	11,290,000
120	8.27	1,995,000	3,100,000	5,175,000	6,225,000	11,730,000
125	8.61	2,070,000	3,215,000	5,370,000	6,460,000	12,170,000
130	8.96	2,145,000	3,330,000	5,564,000	6,690,000	12,610,000
135	9.30	2,220,000	3,445,000	5,758,000	6,925,000	13,050,000
140	9.65	2,295,000	3,565,000	5,952,000	7,160,000	13,490,000
145	9.99	2,370,000	3,680,000	6,146,000	7,390,000	13,930,000
150	10.34	2,445,000	3,795,000	6,340,000	7,630,000	14,370,000

SERIES 374A		
Set Pressure <i>psi</i> <i>bar</i>	$\frac{3}{4}$ " x $\frac{3}{4}$ "	
	20 x 20mm <i>Model M3</i>	
30	2.07	550,000

		SERIES 740				
Set Pressure <i>psi</i> <i>bar</i>	$\frac{3}{4}$ " x 1"	1" x 1 $\frac{1}{4}$ "	1 $\frac{1}{4}$ " x 1 $\frac{1}{2}$ "	1 $\frac{1}{2}$ " x 2"	2" x 2 $\frac{1}{2}$ "	
	20 x 20mm <i>Model M1</i>	25 x 25mm <i>Model M</i>	32 x 32mm <i>Model M</i>	40 x 40mm <i>Model M</i>	50 x 50mm <i>Model M</i>	
30	2.07	925,000	1,300,000	2,105,000	2,900,000	5,250,000
33	2.27	989,000	1,390,000	2,250,000	3,100,000	5,613,000
35	2.41	1,032,000	1,450,000	2,345,000	3,235,000	5,855,000
36	2.48	1,053,000	1,480,000	2,395,000	3,300,000	5,975,000
40	2.76	1,139,000	1,600,000	2,590,000	3,569,000	6,461,000
45	3.10	1,245,000	1,750,000	2,830,000	3,903,000	7,067,000
50	3.45	1,352,000	1,899,000	3,075,000	4,237,000	7,672,000
55	3.79	1,459,000	2,049,000	3,315,000	4,572,000	8,277,000
60	4.13	1,566,000	2,200,000	3,560,000	4,907,000	8,883,000
65	4.58	1,672,000	2,349,000	3,800,000	5,241,000	9,488,000
70	4.82	1,779,000	2,499,000	4,045,000	5,575,000	10,093,000
75	5.17	1,886,000	2,649,000	4,285,000	5,909,000	10,700,000

NOTES

For Technical Assistance Call Your Authorized Watts Agent.

			Telephone #	Fax #
	HEADQUARTERS: Watts Regulator Company	815 Chestnut St., North Andover, MA 01845-6098 U.S.A.	978 688-1811	978 794-1848
North East	Edwards, Platt & Deely, Inc.	271 Royal Ave., Hawthorne, NJ 07506	973 427-2898	973 427-4246
	Edwards, Platt & Deely, Inc.	368 Wyandanch Ave., North Babylon, NY 11703	631 253-0600	631 253-0303
	W. P. Haney Co., Inc.	51 Norfolk Ave., South Easton, MA 02375	508 238-2030	508 238-8353
	WMS Sales, Inc. (Main office)	9580 County Rd., Clarence Center, NY 14032	716 741-9575	716 741-4810
Mid Atlantic	J. B. O'Connor Company, Inc.	P.O. Box 12927, Pittsburgh, PA 15241	724 745-5300	724 745-7420
	RMI	Glenfield Bus. Ctr., 2535 Mechanicsville Tpk., Richmond, VA 23223	804 643-7355	804 643-7380
	The Joyce Agency, Inc.	8442 Alban Rd., Springfield, VA 22150	703 866-3111	703 866-2332
	Vernon Bitzer Associates, Inc.	980 Thomas Drive, Warminster, PA 18974	215 443-7500	215 443-7573
South East	Billingsley & Associates, Inc.	2728 Crestview Ave., Kenner, LA 70062-4829	504 602-8100	504 602-8106
	Billingsley & Associates, Inc.	478 Cheyenne Lane, Madison, MS 39110	601 856-7565	601 856-8390
	Francisco J. Ortiz & Co., Inc.	Charlyn Industrial Pk., Road 190 KM1.9 - Lot #8, Carolina, Puerto Rico 00983	787 769-0085	787 750-5120
	Mid-America Marketing, Inc.	203 Industrial Drive, Birmingham, AL 35211	205 879-3469	205 870-5027
	Mid-America Marketing, Inc.	1364 Foster Avenue, Nashville, TN 37210	615 259-9944	615 259-5111
	Mid-America Marketing, Inc.	5466 Old Hwy. 78, Memphis, TN 38118	901 795-0045	901 795-0394
	Smith & Stevenson Co., Inc.	4935 Chastain Ave., Charlotte, NC 28217	704 525-3388	704 525-6749
	Harry Warren, Inc.	1400 North Orange Blossom Trail, Orlando, FL 32804	407 841-9237	407 841-9246
Watts Georgia	2861-B Bankers Industrial Drive, Atlanta, GA 30360	770 209-3310	770 447-4583	
North Central	Dave Watson Associates	1325 West Beecher, Adrian, MI 49221	517 263-8988	517 263-2328
	Disney McLane & Associates	428 McGregor Ave., Cincinnati, OH 45206	800 542-1682	877 476-1682
	BWA Company	17610 S. Waterloo Rd., Cleveland, OH 44119	216 486-1010	216 486-2860
	Mid-Continent Marketing Services Ltd.	1724 Armitage Ct., Addison, IL 60101	630 953-1211	630 953-1067
	Soderholm & Associates, Inc.	7150 143rd Ave. N.W., Anoka, MN 55303	763 427-9635	763 427-5665
Stickler & Associates	333 North 121 St., Milwaukee, WI 53226	414 771-0400	414 771-3607	
South Central	Hugh M. Cunningham, Inc.	13755 Benchmark, Dallas, TX 75234	972 888-3808	972 888-3838
	HMC Sandia Group	13755 Benchmark, Dallas, TX 75234	505 222-3134	800 339-0191
	Mack McClain & Associates	4407 Meramec Bottom, Suite G, St. Louis, MO 63129	314 894-8188	314 894-8388
	Mack McClain & Associates, Inc.	1450 NE 69th Place, Ste. 56 Ankeny, IA 50021	515 288-0184	515 288-5049
	Mack McClain & Associates, Inc.	15090 West 116th St., Olathe, KS 66062	913 339-6677	913 339-9518
OK! Sales, Inc.	214-A NE 12th., Moore, OK 73160	405 794-5200	405 794-5250	
Western	Delco Sales, Inc.	1930 Raymer Ave., Fullerton, CA 92833	714 888-2444	714 888-2448
	Delco Sales, Inc.	111 Sand Island Access Rd., Unit I-10, Honolulu, HI 96819	808 842-7900	808 842-9625
	Fanning & Associates, Inc.	6765 Franklin St., Denver, CO 80229-7111	303 289-4191	303 286-9069
	Hollabaugh Brothers & Associates	6915 South 194th St., Kent, WA 98032	253 867-5040	253 867-5055
	Hollabaugh Brothers & Associates	3028 S.E. 17th Ave., Portland, OR 97202	503 238-0313	503 235-2824
	P I R Sales, Inc.	3050 North San Marcos Place, Chandler, AZ 85225	480 892-6000	480 892-6096
	Preferred Sales	31177 Wiegman Road, Hayward, CA 94544	510 487-9755	510 476-1595
	R. E. Fitzpatrick Sales, Inc.	4109 West Nike Dr. (8250 South), West Jordan, UT 84088	801 282-0700	801 282-0600
Canada	Watts Industries (Canada) Inc. (Watts Regulator Co. Division)	5435 North Service Road, Burlington, Ontario L7L 5H7	905 332-4090	905 332-7068
	Con-Cur West Marketing, Inc.	71B Clipper Street, Coquitlam, British Columbia V3K 6X2	604 540-5088	604 540-5084
	D.C. Sales Ltd.	#10-6130 4th St. S.E., Calgary, Alberta T2H 2B6	403 253-6808	403 259-8331
	D.C. Sales Ltd.	16726 111 Ave, Edmonton, Alberta T5M 2S6	780 496-9495	780 496-9621
	GTA Sales Team.	Greater Toronto Area	888 208-8927	888 479-2887
	Hydro-Mechanical Sales, Ltd.	3700 Joseph Howe Drive, Suite 1, Halifax, Nova Scotia B3L 4H7	902 443-2274	902 443-2275
	Hydro-Mechanical Sales, Ltd.	P.O. Box 1445 (Mailing), 297 Collishaw St., Suite 7 (shipping) Moncton, New Brunswick E1C 9R2	506 859-1107	506 859-2424
	J.D.S. Sales Ltd.	4 Lancaster Street, St. John's, Newfoundland A1A 5P7	709 579-5771	709 579-1558
	Les Ent. Roland Lajoie	6221 Marivaux, St-Leonard, QC H1P 3H6	514 328-6645	514 328-6131
	Les Ent. Roland Lajoie	23 du Buisson, Pont Rouge, QC G3H 1X9	418 873-2500	418 873-2505
	Mar-Win Agencies, Ltd.	1333 Clifton St., Winnipeg, Manitoba R3E 2V1	204 775-8194	204 786-8016
	Northern Mechanical Sales	P.O. Box 280 (mailing) 163 Pine St. (shipping), Garson, Ontario P3L 1S6	705 693-2715	705 693-4394
	Palsler Enterprises, Ltd.	P.O. Box 28136 (mailing), 1885 Blue Heron Dr., #4, London, Ontario N6H 5L9	519 471-9382	519 471-1049
RAM Mechanical Marketing Inc.	1401 St. John Street, Regina, Saskatchewan S4R 1S5	306 525-1986	306 525-0809	
RAM Mechanical Marketing Inc.	510 Ave M South, Saskatoon, Saskatchewan S7M 2K9	306 244-6622	306 244-0807	
Walmart Mechanical Sales	24 Gurdwara Rd., Nepean, Ontario K2E 8B5	613 225-9774	613 225-0673	
	EXPORT Hdqtrs.: Watts Regulator Co.	815 Chestnut St., North Andover, MA 01845-6098 U.S.A.	978 688-1811	978 794-1848

0804



Water Safety & Flow Control Products

USA: 815 Chestnut St., No. Andover, MA 01845-6098; www.watts.com

Canada: 5435 North Service Rd., Burlington, ONT. L7L 5H7; www.wattscanada.ca